

B28FT

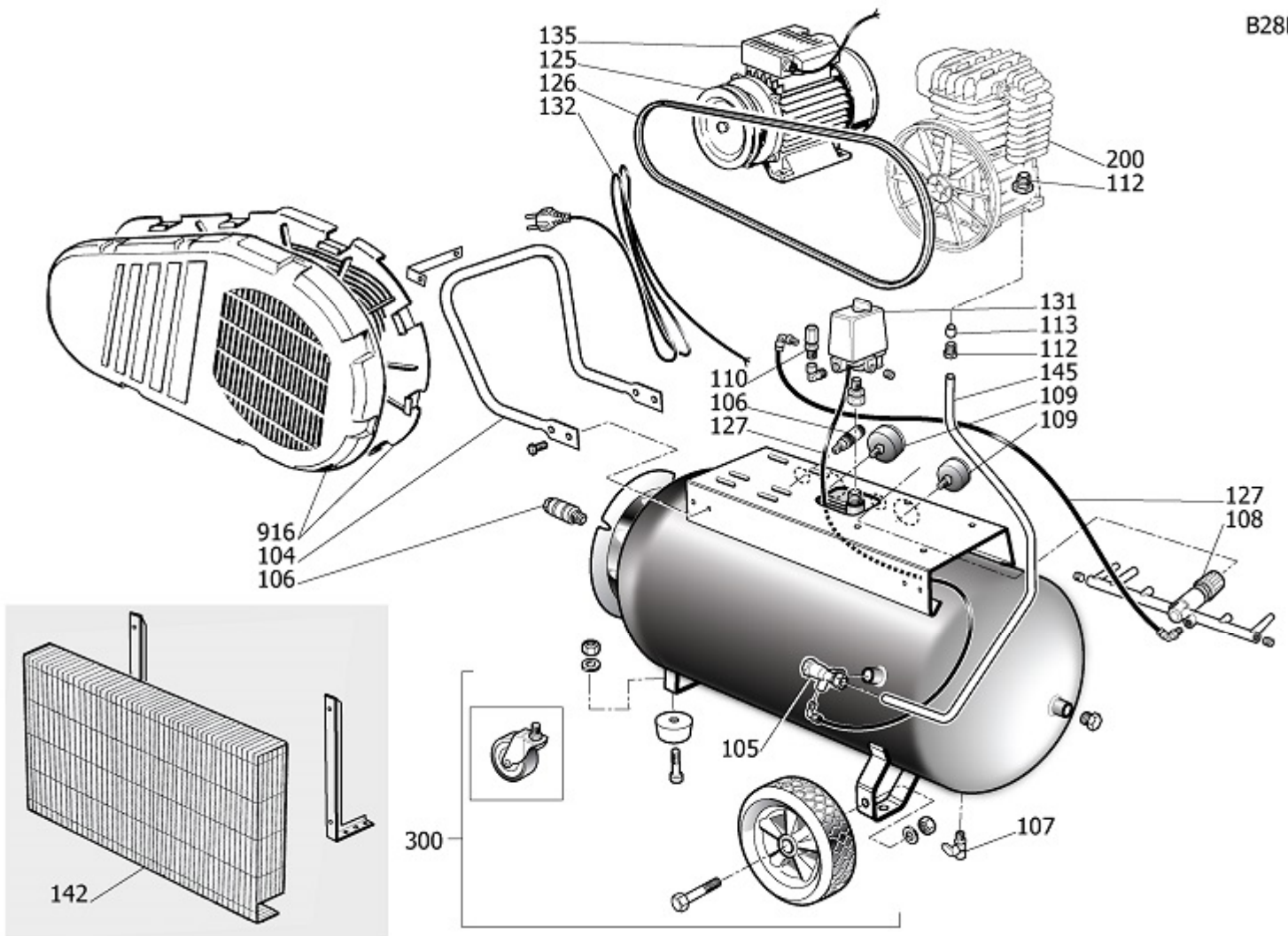

Pos	Component	MU	Multiplier
104	9421478	HANDGRIFF	PZ 1,0
105	9048009	RÜCKSCHLAGVENTIL	PZ 1,0
106	4100811	LEITUNGSHAHN	PZ 1,0
106	9047020	LEITUNGSHAHN	PZ 1,0
107	9047079	KONDENSABLASSHAHN	PZ 1,0
108	9051315	DRUCKREDUZIERER	PZ 1,0
109	9052071	MANOMETER	PZ 1,0
109	9052072	MANOMETER	PZ 1,0
110	9049315	SICHERHEITSVENTIL	PZ 1,0
112	9415903	NIPPEL	PZ 1,0
125	9076003	RIEMENSCHLEIBE	PZ 1,0
126	9075010	RIEMEN POLY V	PZ 1,0
127	9270045	TUBO HYTREL 6X8 NERO	MT 0,5
127	9270046	RILSAN 4X6 SCHWARZ	MT 0,7
131	4100688	KOMPLETTER DRUCKSCHALTER	PZ 1,0
132	9065847	SPEISEKABEL	PZ 1,0
135	84506CA	MOTOR	PZ 1,0
145	9043786	FÜHRERLEITUNG	PZ 1,0
164	#011750000	L-ANSCHLUSS AUTOM.GIR, 1/4 8X6	PZ 1,0
200	280000B	BARE PUMP	PZ 1,0
300	9421436	SATZ-RAD/FEET	PZ 1,0
916	8223070	RIEMENSCHULTZ KIT	PZ 1,0



A28KT



280000B

BARE PUMP

Pos	Component	MU	Multiplier
1	2860101	KURBELGEH[USE	PZ 1,0
2	9428040	ZYLINDER	PZ 1,0
3	3860400	KOPF	PZ 1,0
4	2860200	WELLE	PZ 1,0
5	2660500	DECKEL F]R KURBELGEH[USE	PZ 1,0
23	9428110	ZUSAMMENST. LUFTFILTER	PZ 1,0
26	2060690	VORDERER DECKEL	PZ 1,0
27	2060500	HINTERE HALTERUNG F]R GEH[USE	PZ 1,0
30	9170030	6205.P6.C0.V2.Z2.ROHS	PZ 2,0
32	9022025	\LKONTROLLLEUCHTE	PZ 1,0
33	9024029	\LSTOPFEN	PZ 1,0
34	9163010	DICHTRING	PZ 1,0
900	9434A06	MPK VALVE PLATE B28/B28I/B38	PZ 1,0
901	9434B09	MPK PISTON-CONROD B2800	PZ 1,0
907	9428070	SCHWUNGRAD KIT	PZ 1,0
908	9434E06	MPK AFTERCOOLER B28I/B28/B38	PZ 1,0
909	9434F07	MPK GASKET B28/28I/38	PZ 1,0
912	9434C09	MPK PISTON RINGS B2800/B38	PZ 1,0
922	9434H00	MPK MAINTEN.PV B28/B28I/B38	PZ 1,0