

Akcia platí  
od 18.02.2026  
do 31.12.2026  
prípadne do  
vypredania zásob.  
**PC s DPH**



# CEDIMA



# CTS-57 G

## Stolová píla

### TECHNICKÉ ÚDAJE

Výkon:	2,2 kW/230 V
Otáčky:	2.770 min-1
Max. hrúbka rezu 90°:	125 mm
Max. hrúbka rezu 45°:	75 mm
Max. dĺžka rezu:	600 mm
Max. priemer kotúča:	400x25,4 mm
Zásobník na vodu/vedro:	35 l/20 l
Rozmer (DxŠxV):	1.140x620x1.380 mm
Hmotnosť:	74 kg





Obj.č.

**30001025**

Cena:

**2 276,30 €**

Príslušenstvo	Obj.č.	Popis	Cena €
	30000201	Pravítko / Uholník pre pílu CTS-57 G	172,40
	70008154	Čerpadlo pre pílu CTS-57 G	135,60
	70012077	Vypínač pre pílu CTS-57 G	166,10

# CTS-81 L

## Stolová píla

### TECHNICKÉ ÚDAJE

Výkon:	2,2 kW/230 V
Otáčky:	2.770 min-1
Max. hrúbka rezu 90°:	130 mm
Max. dĺžka rezu:	1.200 mm
Max. priemer kotúča:	400x25,4 mm
Zásobník na vodu/vedro:	35 l/20 l
Rozmer (DxŠxV):	1.560x670x610 mm
Hmotnosť:	94 kg



Obj.č.

**30001046**

Cena:

**3 438,20 €**



# CTS-265.2

## Stolová píla

### TECHNICKÉ ÚDAJE

Výkon:	5,5 kW/400 V
Max. hrúbka rezu:	265 mm
Max. dĺžka rezu:	500 mm
Max. priemer kotúča:	650x25,4 mm
Zásobník na vodu:	50 l
Počítadlo prevádzkových hodín:	Áno
Rozmer (DxŠxV):	1.700x800x1.520 mm
Hmotnosť:	200 kg







Obj.č.

**50007779**

Cena:

**6 402,20 €**

Príslušenstvo	Obj.č.	Popis	Cena €
	70008155	Čerpadlo pre pílu CTS-265.2	235,20
	50006852	Diamantový kotúč na tehlu TS MAXX 650 mm	357,00
	50007533	Diamantový kotúč na betón TS BETON MAXX 650 mm	1 079,30
	50007536	Diamantový kotúč na žulu TS GRANIT MAXX 650 mm	1 190,00

# CBAS-500

## Píla pásová

### TECHNICKÉ ÚDAJE

Výkon:	1,5 kW/230 V
Max. výška rezu:	510 mm
Max. šírka rezu:	490 mm
Max. dĺžka rezu:	690 mm
Šírka stola:	710 mm
Rozmer (DxŠxV):	1.100x1.095x1.845 mm
Hmotnosť:	150 kg

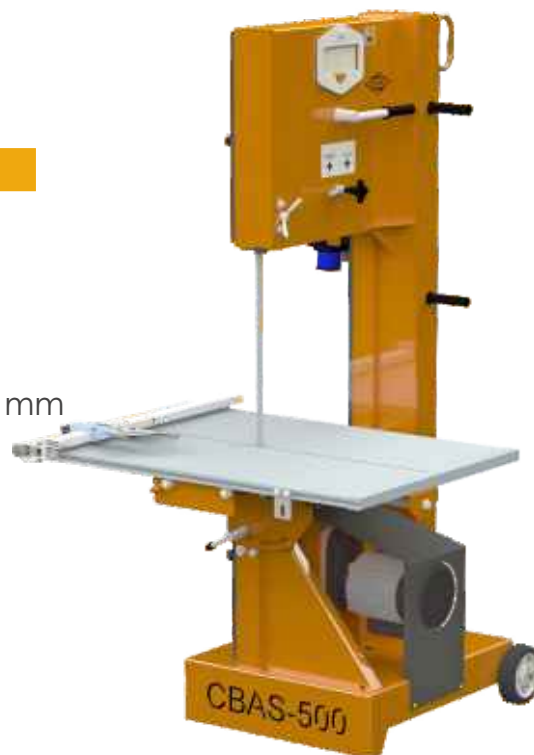

Obj.č.

**50009286**

Cena:

**7 608,00 €**

Príslušenstvo	Obj.č.	Popis	Cena €
	50009324	Pílový pás pre pílu CBAS-500 CSB-HM 3.750x27 mm	345,90

# Diamantové kotúče

BETON AR SOLID	Obj.č.	Rozmery (mm)	Segment (mm)	Použitie	Cena €
-------------------	--------	--------------	--------------	----------	--------



50006141

115x2,2x22,23

10

Betón, Armovaný betón, AR Solid

38,70



50006142

125x2,2x22,23

10

Betón, Armovaný betón, AR Solid

41,50



50006145

230x2,4x22,23

10

Betón, Armovaný betón, AR Solid

83,00

GRANIT NATURAL STONE MAXX	Obj.č.	Rozmery (mm)	Segment (mm)	Použitie	Cena €
------------------------------	--------	--------------	--------------	----------	--------



50007090

125x2,3x22,23

12

Granit, Vymývaný betón, Kameň

84,70



50007093

230x2,6x22,23

15

Granit, Vymývaný betón, Kameň

179,30

GRANIT NATURAL STONE SILENT	Obj.č.	Rozmery (mm)	Segment (mm)	Použitie	Cena €
--------------------------------	--------	--------------	--------------	----------	--------



50007101

230x2,6x22,23

12

Granit, Klinker, Betón, Armovaný betón

199,30



50007103

300x3,0x20,0

12

Granit, Klinker, Betón, Armovaný betón

330,40



50007104

300x3,0x25,4

12

Granit, Klinker, Betón, Armovaný betón

330,40



50007105

350x3,2x20,0

12

Granit, Klinker, Betón, Armovaný betón

438,40



50007106

350x3,2x25,4

12

Granit, Klinker, Betón, Armovaný betón

438,40



50007107

400x3,5x20

12

Granit, Klinker, Betón, Armovaný betón

521,40



50007108

400x3,5x25,4

12

Granit, Klinker, Betón, Armovaný betón

521,40



50007109









450x4,0x25,4



12

Granit, Klinker, Betón, Armovaný betón

637,60

# Diamantové kotúče

FLIES TURBO MAXX	Obj.č.	Rozmery (mm)	Segment (mm)	Použitie	Cena €
	50007053	115x1,2x22,23	10	Obklady, Šamotové tehly, Klinker, Sadrokartón, Profilové plechy	33,20
	50007054	125x1,2x22,23	10	Obklady, Šamotové tehly, Klinker, Sadrokartón, Profilové plechy	38,70
	50007059	230x1,8x22,23	10	Obklady, Šamotové tehly, Klinker, Sadrokartón, Profilové plechy	80,30
	50007057	180x1,8x25,4/22,23	10	Obklady, Šamotové tehly, Klinker, Sadrokartón, Profilové plechy	60,90
	50007058	200x1,8x25,4/22,23	10	Obklady, Šamotové tehly, Klinker, Sadrokartón, Profilové plechy	72,00
	50007060	230x1,8x25,4	10	Obklady, Šamotové tehly, Klinker, Sadrokartón, Profilové plechy	126,20
	50007061	250x1,8x25,4	10	Obklady, Šamotové tehly, Klinker, Sadrokartón, Profilové plechy	116,20
	50007063	300x2,0x25,4	10	Obklady, Šamotové tehly, Klinker, Sadrokartón, Profilové plechy	124,50

CST SOLID	Obj.č.	Rozmery (mm)	Segment (mm)	Použitie	Cena €
	50007546	125x7,0x22,23	7	Betón, Klinker, Kameň	161,10
	50007547	180x7,5x22,23	7,5	Betón, Klinker, Kameň	239,10

